

§-6

\* **IN THE HIGH COURT OF DELHI AT NEW DELHI**  
+ FAO(OS) (COMM) 151/2022, CM APPL. 27739/2022, CM APPL.  
27740/2022, CM APPL. 27741/2022  
V GUARD INDUSTRIES LTD ..... Appellant

Through: Mr. Sachin Gupta, Ms. Jasleen Kaur,  
Ms. Snehal Singh & Mr. Jaydeep  
Roy, Advs.

versus

SH SAGAR BHAWNANI PROPRIETOR PARTNER OF M S DEEP  
INDUSTRIES & ORS. .... Respondents

Through: None

**CORAM:**  
**HON'BLE MR. JUSTICE VIBHU BAKHRU**  
**HON'BLE MR. JUSTICE AMIT MAHAJAN**

**ORDER**

**03.06.2022**

%

**FAO(OS) (COMM) 151/2022, CM APPL. 27742/2022 (for stay)**

1. The appellant has filed the present plea impugning an order dated 31.05.2022 passed by the learned Single Judge in the application filed under Order XXXIX Rule (1) and (2) in CS(COMM) 378/2022 captioned "V Guard Industries Ltd. v. Sh Sagar Bhawnani & Ors."
2. The appellant had filed the said suit seeking permanent injunction restraining infringement of its design, unfair competition, damages, delivery, etc.
3. The appellant alleges that the respondents/ defendants are dealing in

FAO(OS) (COMM) 151/2022

  
4/6/22  
For **Court Master**  
**High Court of Delhi**  
**New Delhi**

Page 1 of 6

ceiling fans of a certain design that infringes the appellant's registered design 33062-001 dated 01.07.2020 in Class 25-04.

4. The appellant has produced a copy of the certificate of registration of the said design. The extract of the same that indicates the particular design features of the ceiling fan which have been registered in favour of the appellant, is reproduced below:

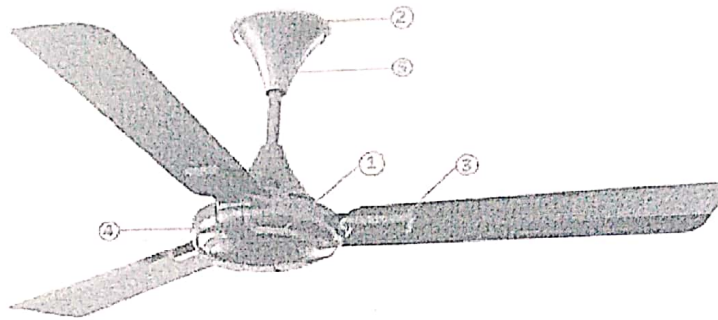

Perspective view – Bottom

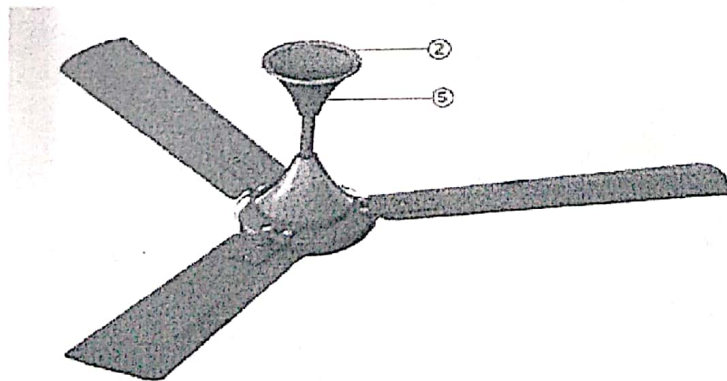

Perspective view – Top

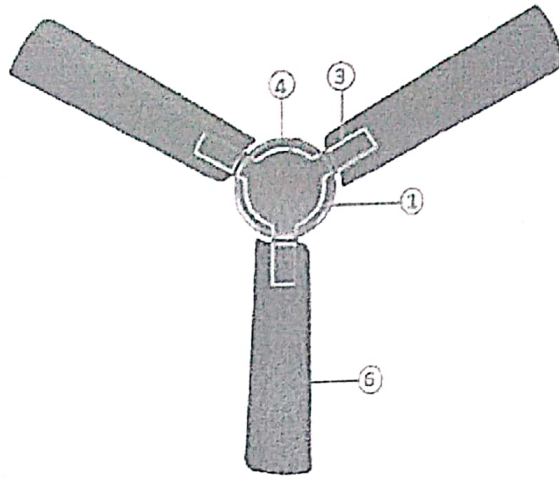

Bottom view

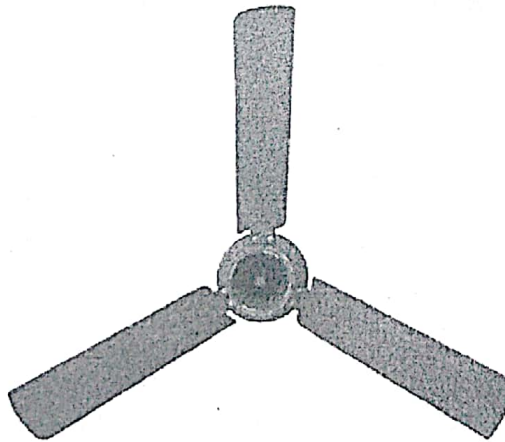

Top view

5. The tabular statement indicating the products of the appellant and the

Pr *Pani*  
4/6/22  
**Court Master**  
**High Court of Delhi**  
**New Delhi**

allegedly infringing goods manufactured/ dealt with by the respondents as stated in the plaint is set out below:

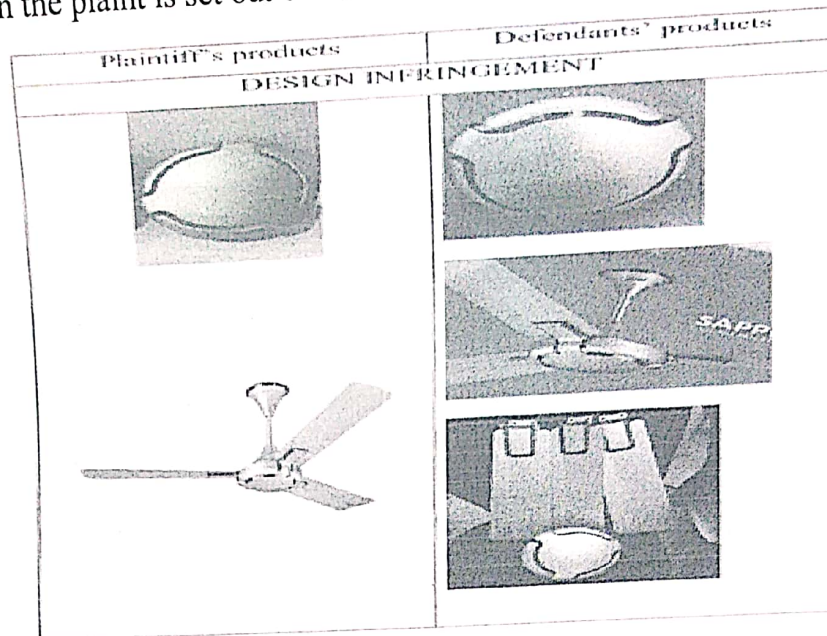

6. It does *prima facie* appears from the aforesaid images that the goods of the respondent's product infringe the appellant's design – Design no. 33062-001.

7. The learned Single Judge has not acceded to the appellant's request for an *ex parte ad interim* order. This Court is of the view that the denial of an *ex parte ad interim* order at this stage would unfairly prejudice the appellant.

8. In view of the above, the respondents are restrained from manufacturing, selling or dealing with any ceiling fans which infringes the appellant's registered design or is in any manner deceptively similar to the said design, till the next date of hearing.

9. The respondents are at liberty to apply.

10. List on 04.07.2022.

FAO(OS) (COMM) 151/2022

Page 4 of 6

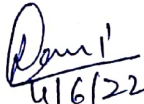
  
 4/6/22  
 for Court Master  
 High Court of Delhi  
 New Delhi

CM APPL. 27743/2022 (for appointment of Local Commissioner)

11. The appellants states that the sale of ceiling fans in summer months is usually higher than in other months and it would be essential to appoint a Local Commissioner to make an inventory of the offending goods and seize the same.

12. In the given circumstances, this court considers it apposite that an inventory of the stock of allegedly offending goods be taken but it is not necessary to direct seizure of the said goods at this stage.

13. For the reasons stated above, Mr. Shashi Shekhar, Adv. (Mob. No. 9711077890) is appointed as a Local Commissioner to visit the following premises of the respondents:

Respondent No. 1 & 2

Sh. Sagar Bhawnani/ Sh. Amar Lal Bhawnani  
Proprietors/ Partners of M/s Deep Industries  
H-110, Sector-1, DSIIDC Industrial Area  
Bawana, Delhi-110039

14. The Local Commissioner shall also be entitled to break locks and enter the premises with police assistance, if necessary.

15. The Local Commissioner shall make an inventory of the goods available at the said premises, that infringe the appellant's design or are otherwise deceptively similar to the same. The Local Commissioner shall also take images of the said goods.

16. The representatives of the appellant would be entitled to accompany the Local Commissioner.

17. The concerned SHO is directed to render full assistance to the Local Commissioner to execute the commission.
18. The fees of the Local Commissioner is fixed at ₹1,00,000/-, which shall be paid by the appellant.
19. This application stands disposed of with the aforesaid directions.
20. *Dasti* under signatures of the Court Master.

VIBHU BAKHRU, J

AMIT MAHAJAN, J

JUNE 3, 2022  
SS

  
for Court Master  
High Court of Delhi  
New Delhi